

Wire Straightening and Cutting Machines for the Production of Straightened Rods Made of Round Wire



R 13
R 23
R 53

R 13
R 23
R 53

▼ Infeed with straightening unit

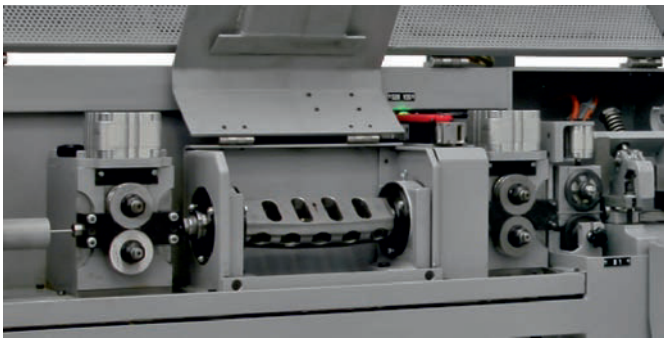

▼ Stationary cut

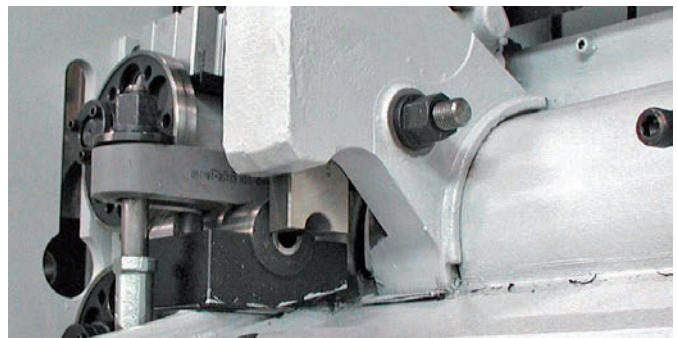

Our Accomplishments for your Benefit

- More powerful while offering even more operating convenience
- Minimized set-up times
- Optimized and language neutral operator guidance
- Several partial use of the tools of previous models
- Improved working conditions due to service instructions, electronically stored operating instructions

Design Features

Efficiency

- Push and pull rollers for wire feed (just pull rollers for R 13)
- Robust rotary straightening system
- High-performance cut
- Increased output with compact rotors (option R 23)

Infeed

- Separately driven infeed modules
- Opening and closing of the feed rollers at the panel
- NEW: settings and storage of the push and pull roller pressure at the panel

Cut

- Reduction of noise and wear due to servo drive
- Increased number of cuts (option R 23)

Cut Release

- Manually adjustable release head (option R 53)
- Length measuring device (option R 23, R 53)
- Fixed stop for short lengths (option)
- Length stop with electrical contact for length control during production (option R 23, R 53)

Operation

- Reduced set-up times due to ergonomic access to all tools
- NEW: User-friendly color Touch Screen with masks e. g. ROD EASY mask: A selection of fixed wire diameter and wire type is stored. The values for the straightening ratio and the pressure of the feed rollers are applied automatically. In addition, the Operator can store their own types of wire.

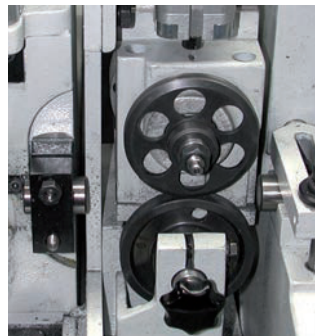

▲ Measuring wheel



▲ Graphical operator guidance via color touch screen

Quality, Reliability and Efficiency – WAFIOS Straightening and Cutting-Off Machines

New Definition of Productivity

WAFIOS R machines have been designed for the production of straightened and cut-off rods. They provide new technical solutions for increasing your output and optimizing costs.

The standard equipment of these machines includes up to 4 drives. As an option, the machines can be fitted with an additional push roller pair and a straightening system with a larger spacing to use the machines also in the larger diameter range.

Further options are compact rotors (R 23) and a freely selectable number of cuts (R 23) to increase the output, as well as different extension versions for increasing the machines' efficiency. Moreover, tools and devices for processing profiles are also available if required.

Quality

For more than 130 years the name WAFIOS has stood for the highest in terms of quality expectations, safety standards and technical innovation in German manufacturing systems engineering.

Reliability

Strict quality controls, state-of-the-art production systems and many years of experience guarantee that your investment is in safe hands. Our global service network ensures high availability of WAFIOS machinery.

Efficiency

High production output and a long service life will save money and shorten the amortization time of your investment.

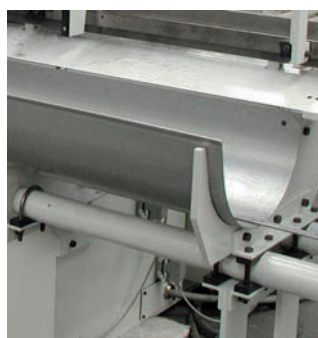

▲ Collecting trough



▲ Tilting station

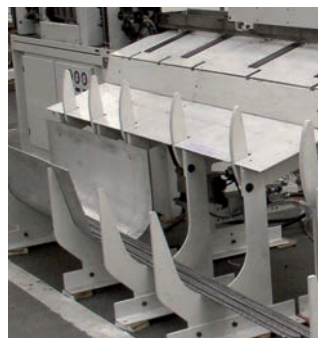

▲ Tilting and collecting station



▲ Stop of tilting station and rod-end alignment

Technical Data	R 13	R 23	R 23S	R 53	R 53 Cut and rotor drive reinforced****
Feed rate (m/min)	3 - 90	5 - 120	5 - 140	5 - 160	5 - 140
Wire Ø (mm) ***	(Standard)	(Standard) (B version)	(2 rotors)	(Standard) (B version)	
400-800 (N/mm ²)	0.65 - 2.5	1.0 - 4.0 1.0 - 4.0	1.0 - 3.5	5.6 - 14.0 7.0 - 15.0	7.0 - 15.0 (1,350 (N/mm ²))
800-1,200 (N/mm ²)	0.80 - 2.0	1.2 - 3.6 1.2 - 3.6	1.2 - 3.0	6.0 - 12.0 7.0 - 13.0	7.0 - 14.0 (1,550 (N/mm ²))
1,200-1,600 (N/mm ²)	0.80 - 1.6	1.2 - 3.2 1.2 - 3.2		6.0 - 11.0 7.0 - 12.0	7.0 - 13.0 (1,800 (N/mm ²)) 7.0 - 12.0 (2,000 (N/mm ²))
Shortest cutting lengths (mm) with flat wire guide					
- with length measuring unit	150	150	150	200	200
- with release head	---	300**	---	500	---
- with round wire guide	75	75	---	---	---
- with fixed stop	25 - 150	20 - 150	20 - 150	75 - 200	75 - 200
Cuts per minute max. with fixed stop (option)	160 276	160 / 300* 276	180 / 300* 276	100 162	100 162
Space required (l x w x h) (mm) w/o directly attached construction	1,220 x 700 x 2,070	1,220 x 700 x 2,070	1,220 x 700 x 2,070	2,960 x 1,300 x 2,450	2,960 x 1,300 x 2,450

* Option: freely selectable number of cuts, only in combination with a measuring wheel

** From 2.5 mm

*** Reinforcing steel cold rolled, measured across the ribs

**** Only in combination with a measuring wheel

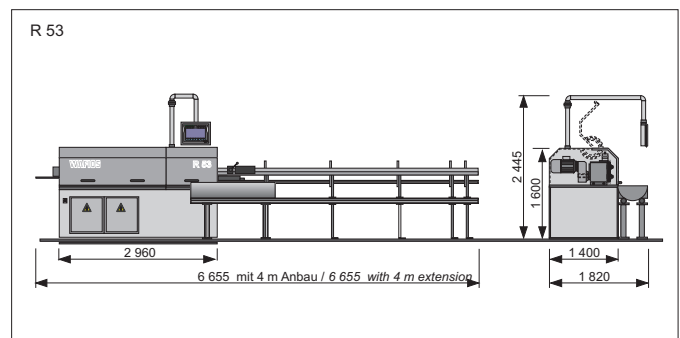
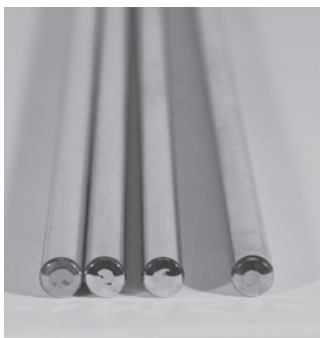

WAFIOS AG

Silberburgstraße 5
72764 Reutlingen, Germany
Tel. +49 (0) 7121 146-0
Fax +49 (0) 7121 146-250
sales@wafios.de
www.wafios.com

Precision Machinery for Wire and Tube