

FMK 3 – Combined tool for coiling and cutting

The new tool-change system combines the tools for cutting and coiling on one holder. In this way, the distances between the two processes winding and cutting, will be shortened. Thus, the production time - depending on the product - could be significantly reduced.

Holder and tools

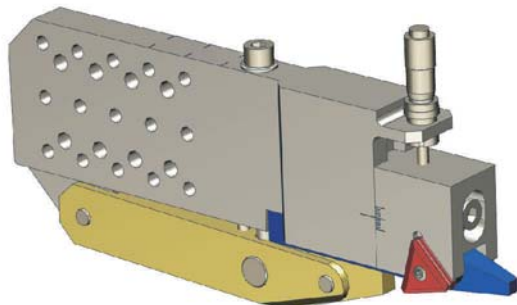

▲ Combined tool: coiling

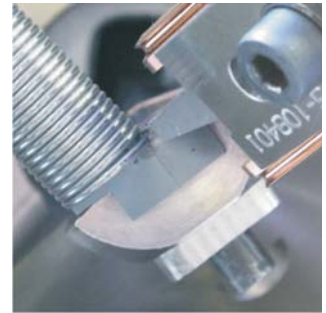

▲ Combined tool: cutting

Cost reduction by coiling plates with three different groove diameters

Cumulated costs for coiling plates
(complete working range)

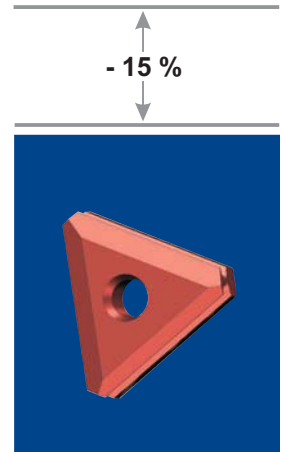
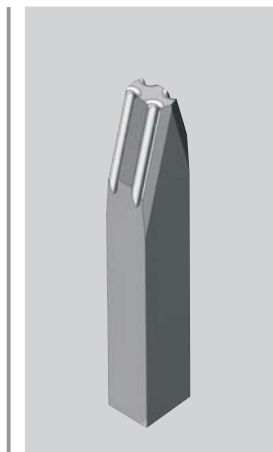

Your benefit

- Shorter distances between the operations “coiling” and “cutting”
- 1 more free holder for additional tool
- Increase of production speed
- Cost saving by turnable coiling plates with three different groove diameters (within range of 1,7-3,2 mm)
- All components available separately

Contact:

E-Mail: Tools@wafios.de
 Phone: +49 (0)7121 / 146 1836
 Fax: +49 (0)7121 / 146 202

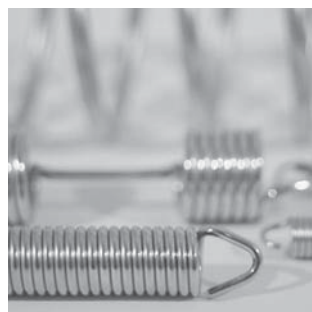

FMK 3 – Combined tool for coiling and cutting

Combined tool - Standard-Set - 2634-3-108000

contains

Designation	Part no.
1x Holder	2634-4-108100
1x Coiling plate holder for wire-Ø 1,2 – 1,6 mm	2634-4-108400
1x Coiling plate holder for wire-Ø 1,7 – 2,2 mm	2634-4-108500
1x Coiling plate holder for wire-Ø 2,3 – 3,2 mm	2634-4-108600

Coiling plate holder for wire-Ø 1,2 - 1,6 mm, Part no. 2634-4-108400

applicable with **Coiling plates**

Wire-Ø	Part no.
Ø 1,2 mm	2632-5-084112
Ø 1,3 – 1,4 mm	2632-5-084114
Ø 1,5 – 1,6 mm	2632-5-084116

Coiling plate holder for wire-Ø 1,7 - 2,2 mm, Part no. 2634-4-108500

applicable with **Coiling plates**

Wire-Ø	Part no.
Ø 1,7 – 1,8 mm	9998-5-010220
Ø 1,9 – 2,0 mm	
Ø 2,1 – 2,2 mm	

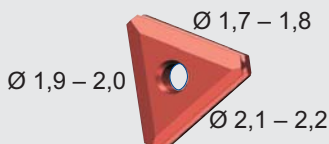

Coiling plate holder for wire-Ø 2,3 - 3,2 mm, Part no. 2634-4-108600

applicable with **Coiling plates**

Wire-Ø	Part no.
Ø 2,3 – 2,5 mm	9998-5-010221
Ø 2,6 – 2,8 mm	
Ø 2,9 – 3,2 mm	

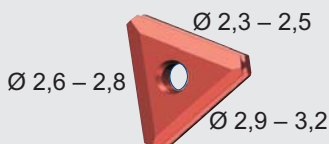

Cutter, Part no. 2634-5-085100